

Bray[®] CONTROLS



PNEUMATIC
Actuators & Accessories



Pneumatic Actuators & Accessories

Page

Series 92/93 Pneumatic Actuator **4**

Series 63 Solenoid - Direct Mount **6**

Series 50 Valve Status Monitor
Limit Switch **8**

Series 52 Valve Status Monitor
Limit Switch **10**

Series 6A Electro-Pneumatic
Positioner **12**

Series 6P Pneumatic Positioner **14**

Series 55 Filter Regulator **15**



Bray[®] CONTROLS



INTRODUCTION

Through years of field application experience, research and development, we have designed products that meet the stringent requirements of today's fluid process industry. Bray has earned a reputation of excellence by creating products of superior value and quality, providing personalized customer service and on-time deliveries. Our success has always been the direct result of our fully integrated, full range butterfly valve and control product lines. Rugged and reliable, our products are engineered to provide years of trouble free service.

Bray products are used in a wide range of industries worldwide including:

- Chemical
- Beverages
- Pharmaceuticals
- Food Processing
- Petroleum Refining & Oilfield
- Transportation
- Microprocessors
- Marine
- Pulp & Paper
- Mining
- Power/FGD
- Irrigation
- Water & Wastewater Treatment
- Textile
- Desalination
- Steel Production
- Sugar/Ethanol
- HVAC
- Breweries/Wineries

PRODUCT QUALITY & PRECISION

Assuring product quality, precision manufacturing and internal process integrity, Bray Controls has been certified to ISO 9001 quality standards. The certification of compliance was issued by Lloyd's Register Quality Assurance (LQRA), a worldwide independent certifier. The basis for Bray Controls' high level of quality assurance are the quality control guidelines and procedures submitted, reviewed and approved in accordance with criteria established within ISO 9001:2000 and EU Directives.

“Bray Controls is focused on and committed to meeting the expectations and needs of our customers while continually improving the effectiveness of our quality management.”

- All Bray valves are pressure tested to 110% of rated pressure to assure bubble-tight shutoff.
- All Actuators are calibrated and cycle tested before shipment. Pneumatic actuators are also pressure tested to assure no leakage.
- Material Traceability - Certification is provided for all valves upon request for all pressure retaining components.
- Positive Material Identification - All materials are subjected to PMI testing to verify material traceability certificate.



BRAY SERIES 92/93 PNEUMATIC ACTUATOR



Output Torques to 44,130 Lb-in (4,986 N-m)

Styling, strength, compactness, and simplicity of design have been combined to produce the Bray Series 92 direct acting and the Series 93 spring return pneumatic actuators.

Engineering excellence and precision manufacturing has produced a modular product line with reduced overall size requirements and economic savings. In addition all Bray accessories are fully modular and directly mount to the actuator – providing flexibility and efficiency at reduced cost.

Bray Series 92/93 actuators are rack and pinion, opposed-piston actuators available in two versions: double acting for rotation of 90°, and spring return for 90° rotation.



SERIES 93

All double acting and spring return units are suitable for both on-off and throttling applications. Actuators which can be actuated with other media such as hydraulic oil or water are also available as an option.

STANDARD MATERIALS SELECTION

NAME	MATERIAL
Body	Extruded Aluminum Alloy, Anodized 316 Stainless Steel
End Caps	Die cast Aluminum Alloy with Corrosion Resistant Polyester Coating 316 Stainless Steel
Pistons	Die Cast Aluminum Alloy
Output Shaft/Pinion	Carbon Steel, Zinc Plated
Travel Stop	Alloy Steel
Shaft Bearings	Acetal
Piston Guides	Acetal
Fasteners	Stainless Steel
Springs	Spring Steel, Protective Coating
Piston O-Ring Seals	BUNA-N
Options:	Polyester Coated Body Exterior Electroless Nickel Plated Body Exterior Hard Anodized Body Exterior Seacorr Coated Body Exterior Stainless Steel Pinion
Temperature Range	Standard -4°F to 200°F (-20°C to 93°C)
	Low -40°F to 176°F (-40°C to 80°C)
	High 0°F to 300°F (-18°C to 149°C)
Note: Cycle life on low and high temperature seal kits reduced compared to standard Buna N seals	
Series 92 Double Acting	Available in 90°
Series 93 Spring Return	Available in 90° Rotation Operating Pressure 140 psig (10 bar) maximum



DIRECT MOUNTING

Bray actuators comply with ISO 5211 dimensions and mount directly to Bray valves without using external linkages. Field installation is simple, misalignment is minimized and contamination buildup between valve and actuator is reduced.

PNEUMATIC ACTUATOR OPTIONS



SERIES 5 - DECLUTCHABLE GEAR OPERATOR



STAINLESS STEEL



EXTENDED TRAVEL STOPS

All Bray Series 92/93 actuators have permanently lubricated bearings and guides.

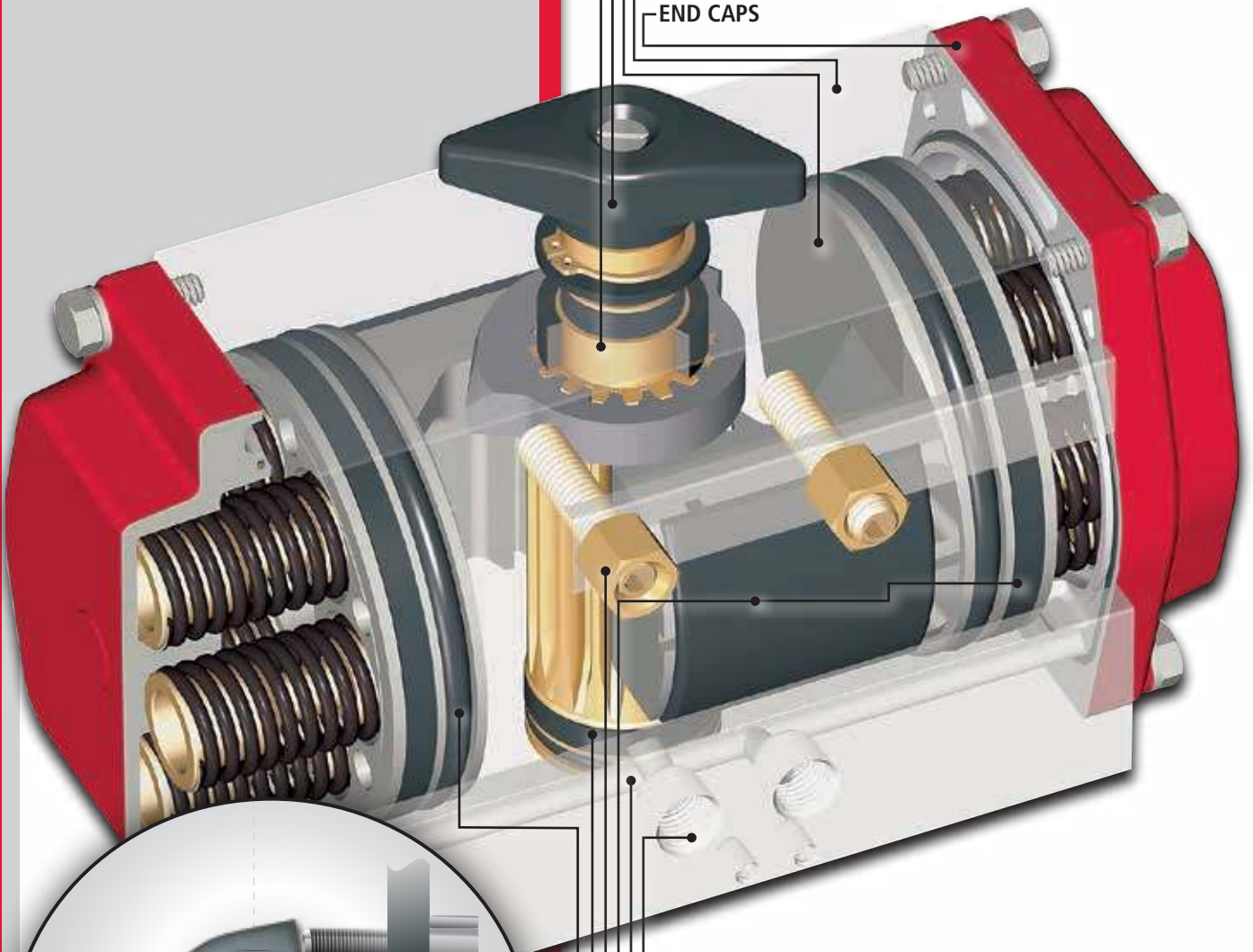

TRAVEL STOP ADJUSTMENT

The 0° and 90° travel positions have travel adjustments of +5° max. to -5° min. Extended travel stops are also offered as an option.

OUTPUT SHAFT and PINION GEAR

POSITION INDICATOR

PISTONS

BODY

END CAPS

PNEUMATIC SUPPLY PORTS: Available imperial or metric. NAMUR interface for accessory mounting is standard on all actuator sizes.

INTEGRAL PORTING: Reduces the cost of external tubing that is also easily damaged.

PISTON GUIDES and RINGS: Provide low coefficient of friction and absorb the side thrusts of the pistons.

TRAVEL STOPS: Adjusting screws limit the travel of the actuator to specific degrees of rotation in both open and closed directions.

OUTPUT SHAFT BEARINGS: Top and bottom of the pinion.

PISTON O-RING SEALS

BRAY SERIES 63

SOLENOIDS PILOT OPERATED SPOOL CONTROL

These units can be used with either spring return or double acting actuators where on/off electrical operation is required. Units have 1/2" NPT conduit connections and IP65 DIN units have cable gland PG9 connectors, also available with 1/2" NPT conduit adapters. The coils are UL recognized and CSA certified. All Series 63 solenoids carry the CE mark.

FEATURES:

- Compact
- Modular
- Pilot Operated
- Spool Control Valve
- Convertible From 3-Way (3/2) to 4-Way (5/2)
- Spring Return or Double Acting

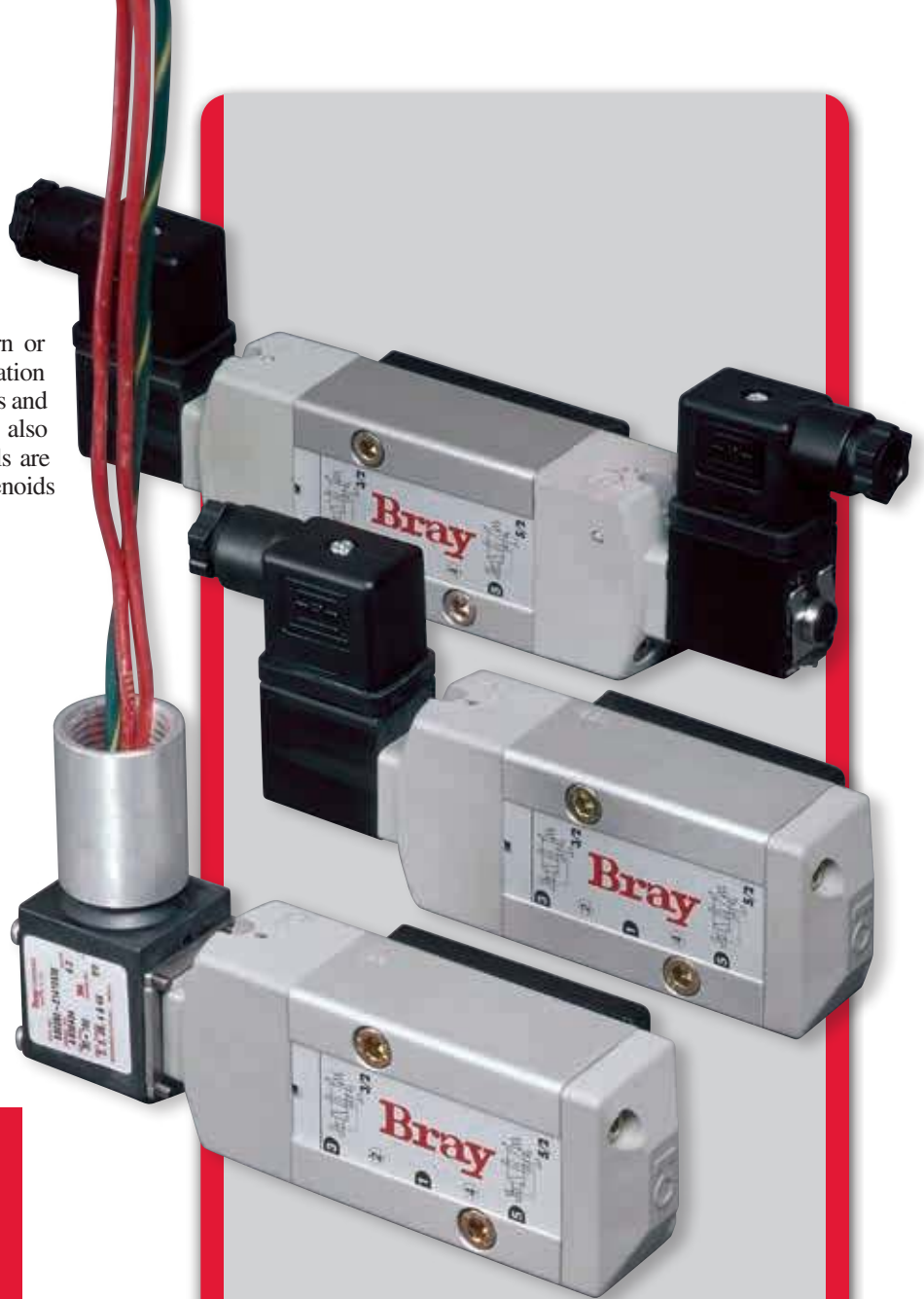

SOLENOID OPTIONS

- Stainless steel housings
- Low-powered units
- Intrinsically safe units
- BUS solenoids are available for DeviceNet and Profibus-PA protocols
- AS-I Interface solenoids with IP65 DIN/PG9 cable gland connectors are available
- All direct mount to Bray pneumatic actuators.
- Speed controls that allow independent control of speed in both directions



MANUAL OVERRIDE: Each unit contains as standard a mechanical manual override located on the solenoid valve block. In the event of electrical power failure, over-riding is accomplished by rotating the manual override screw which will divert the air from one chamber of the pneumatic actuator to the other.

VALVE DESIGN: Pilot Operated Spool

MEDIA: Dry or lubricated air or inert gases

COIL HOUSINGS: Three standard coil housings are offered.

1. **Watertight** (NEMA 4, 4x) housing offers a molded and potted coil with UL recognized components and CSA certification.

2. **Watertight & Explosion Proof** (NEMA 4, 4x, 7, 9) housing is UL listed and C.S.A. certified for hazardous locations Class I, Div.1 (Groups A-D) and Class II, Div.1 (Groups E-G).

3. IP65 DIN

Standard solenoid valves are supplied as single coil units. Dual coil units are also available for customers who require actuators to remain in last position during electrical power failure.

SPRING RETURN ACTUATORS: The Series 63 Solenoid Valve fills the spring chamber with supply air rather than drawing air from the surrounding atmosphere. This keeps the spring chamber clean and dry, and improves the performance and service life of the actuator.

DIRECT MOUNTING

DIRECT MOUNTING: Meeting NAMUR (VDI/VDE 3845) standards, all Bray Series 63 solenoid valves direct mount to the integral porting system of Bray Series 92/93 pneumatic actuators. No external piping is required. Bray's direct mounting permits quick and simple field installation.



SERIES 63 - MECHANICAL CHARACTERISTICS

MOUNTING NAMUR (VDI/VDE 3845), mountable in any position, hardware included.

MATERIALS

Body: Anodized Aluminum
 Spring: Phosphate treated black steel
 Shading Coil: Copper
 Seals: NBR + PUR
 Core / Tube: Stainless / Brass
 End Covers & Plate: 6/6 glass filled polyamide (PA/FV)
 Spool: Aluminum
 Internal Parts: Zamak, Steel, Acetal

PNEUMATIC PORTS 1/4" NPT

ELECTRICAL CONNECTIONS NEMA Housings: 1/2" NPT
 DIN Housing: Cable Gland PG9

CONSTRUCTION

Standard construction is molded and potted coil with 18" leads, Class F insulation. Other insulation classes available. The IP65 DIN coil and magnet structure are epoxy encased. Molded cordsets and connectors are available for IP65 DIN coil housings, please consult Bray representative or factory for further information.

NORMAL AMBIENT TEMPERATURE RANGE

NEMA Housings: AC: -13°F (-25°C) to +140°F (+60°C)
 DC: -13°F (-25°C) to +77°F (+25°C)

ELECTRICAL COIL

NEMA Housings with flying leads 12, 24, 120, 220 VAC, 50-60 HZ
 12, 24, 120 VDC
 IP65 DIN Housings Type "I" Connection 24, 120, 240 VAC, 50-60 HZ
 24 VDC

NEMA & IP65 DIN Coil Insulation-Class F
 Max Temperature Rating: 311°F (155°C)
 Max Ambient Temperature Rating: 158°F (70°C)

FLOW

1/4" (6.35 mm) PIPE C_v = .7 Flow = 30 scfm, 150 psi (10.4 bar) max.

Bray S92/93 actuation times are very dependent on the flow capacity of their air supply. It is strongly recommended that only the Bray S63 high flow solenoid be used with the Bray S92/93 actuators. The use of smaller port solenoids, solenoid manifolds, small I.D. air supply tubing and/or extended lengths of tubing can significantly reduce the actuation time and/or the initial response to the command signal. Please see TB-1140 for pneumatic FLOW TESTING RECOMMENDATIONS.

NOMINAL POWER (WATTS)

NEMA Housing AC - 6.3, DC - 6.9
 DIN Housing AC - 2.5, DC - 3.0

OPERATING SPEED 10 cycles per minute - with more if needed

DUTY CYCLE Continuous

BRAY SERIES 50 VALVE STATUS MONITORS

The Series 50 signals actuator and valve position to local and remote stations. The units have been designed for ease of wiring and a wide variety of switches. Both feature the same high quality internal parts and the same rugged reliability.

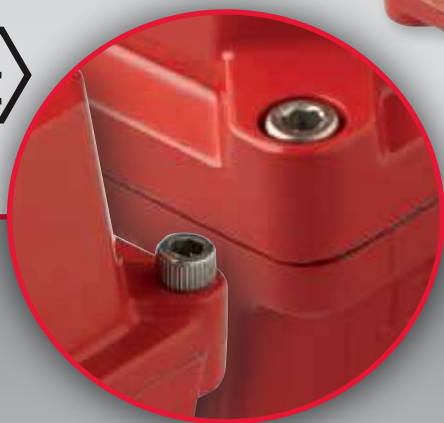

CAPTIVE HOUSING BOLTS

The housing covers of Bray Valve Status Monitors are attached to the housing bases by stainless steel bolts. When the cover is removed the bolts are held captive in the cover. This prevents time consuming problems caused from lost or misplaced bolts.



HIGH VISIBILITY DISPLAY AVAILABLE

Prominently labeled and color coded – yellow for open, red for closed – the display indicates valve position through the full range of travel. Made of high impact, heat and chemical resistant clear polycarbonate, this display withstands caustic washdown and offers excellent corrosion protection.

SERIES 50-0400

Waterproof
NEMA-4, 4X, IP 65



SHAFT BEARINGS: The Series 50-0400 has acetal bearings on the top and bottom of the shaft which reduce friction and eliminate shaft binding.

CAMS / CAM ADJUSTMENT: A cam for each switch is mounted directly to the output shaft and each cam is color coded – red adjustment screw matches red cam (valve closed indication), green screw matches green cam (valve open indication). The cams are infinitely and independently adjustable from the top by finger touch or regular screw driver with no special tools needed. The adjustment screws rotate the eccentric shaped cams. Set screw will prevent cams from slipping out of adjustment from line vibration.

O-RING SEALS: Seals on the shaft and housing provide a waterproof enclosure and prevent internal corrosion.

POSITION INDICATORS: Bray has specially designed position indicators which locally signal valve position. The pointer, made of ABS, comes standard with all Series 50 units.

HOUSING: Die Cast Aluminum with standard coating. Seacorr Coated Body Exterior also available.

A Bray Series 63 solenoid valve can be easily terminated in Series 50-0700 valve status monitor.

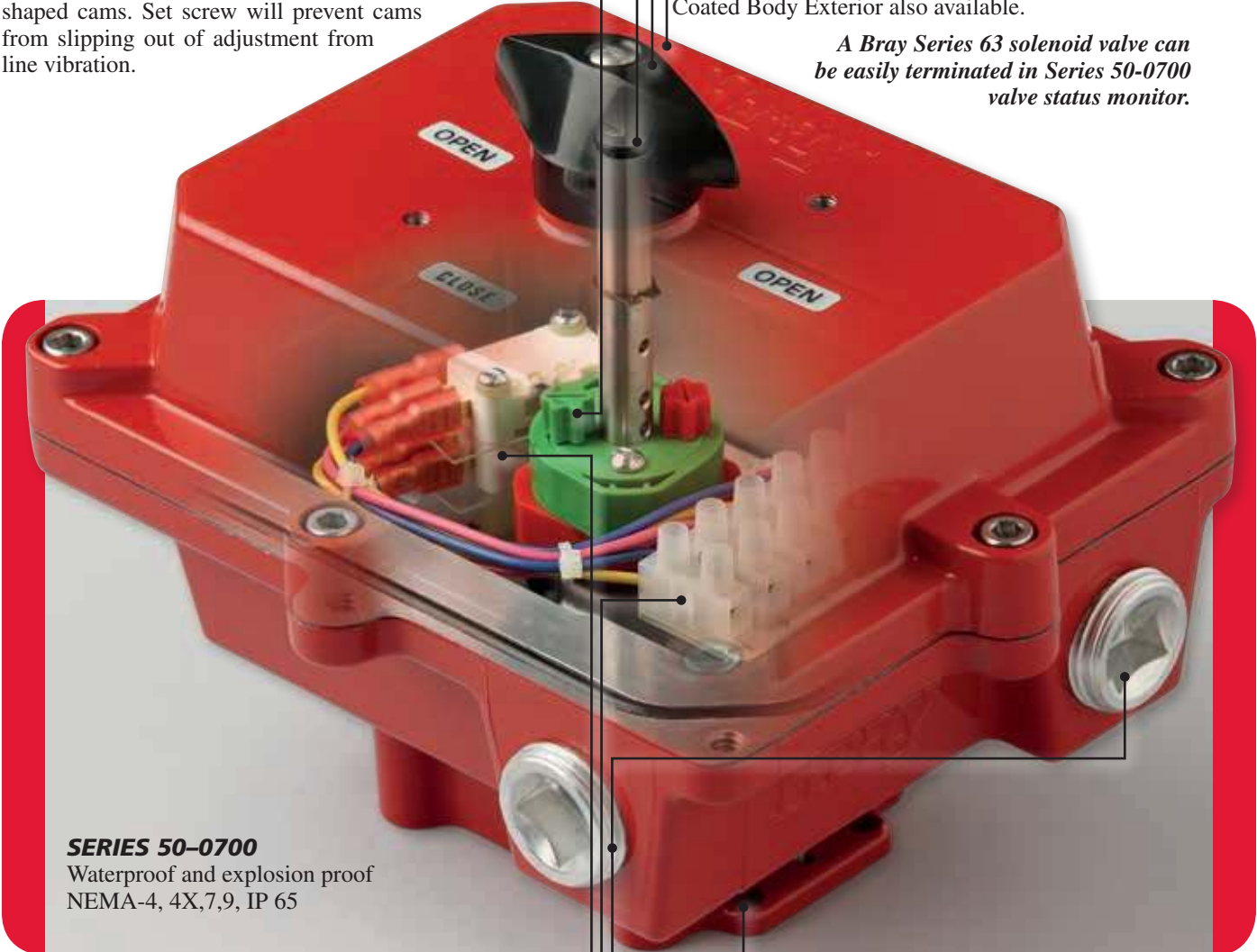

SERIES 50-0700
Waterproof and explosion proof
NEMA-4, 4X,7,9, IP 65

SWITCHES: Series 50 Valve Status Monitors come standard with 2 SPDT V3 switches. Additional switches and other switch options are available in the 50-0700 units. Please consult your factory representative.

TERMINAL BLOCK: The internal switches are pre-wired to a terminal block. The block has been designed for ease of wiring installation with clearly marked numbers for both open and closed switches.

CONDUIT ENTRIES: two conduit entries. The Series 50-0400 unit has 1/2" NPT (M20) conduit connections, and the Series 50-0700 has 3/4" NPT (M25) conduit connections.

DIRECT MOUNTING A compact, modular design allows direct mounting of the Bray Series 50 to pneumatic actuators without any brackets or couplings. The mounting pattern complies with VDI/VDE 3845 (NAMUR recommendations).

**SERIES 50-0700
AVAILABLE SWITCHES:**

- Micro switches
- Proximity switches
- Pneumatic switches
- Reed switches
- Potentiometer

*Other switches are available.
Please consult your factory representative.*

BRAY SERIES 52 VALVE STATUS MONITOR

Bray's 2N1 ProxSensor has combined two proximity sensors in one self-contained, fully sealed, compact enclosure. DeviceNet, PROFIBUS DP and AS-i BUS network units with solenoid drive are also available.

The Series 52 offers the bounce-free electronic valve signaling required for all PLC, computer and solid state circuitry vital to process control and information networks. Costly external junction boxes are eliminated and field wiring costs are greatly reduced. Bray's approach delivers the most compact, reliable and economical valve position monitoring system available.

MOISTURE, CHEMICAL AND CORROSION PROTECTION:

The two proximity sensors are completely encapsulated with epoxy resin in a rigid polymer enclosure that is impervious to moisture and most chemical and corrosive agents. Once the multi-pin connection is made, the cable link to plant wiring is completely sealed eliminating the possibility of failure due to moisture. These protections make the Series 52 the best choice for hostile environments.

ELECTRICAL CONNECTION: A multi-pin electrical connector is designed for full compatibility with today's industrial wiring requirements.

POLYMER ENCLOSURE: Bray's design of two sensors in one rugged enclosure greatly reduces space requirements and expensive housings needed for previous dual switch applications. The epoxy resin encapsulation protects the sensors against vibration or shock.

LOCAL POSITION INDICATION: A Valve Position Pointer, made of highly visible yellow ABS material, shows valve position locally throughout the full range of travel.

- **LED Indicators** give positive verification that the sensors are electrically functioning and show the target position has been reached.
- **High Visibility Valve Position Display** (optional) Prominently labeled and color coded – yellow for open, black for closed – the display indicates valve position throughout the full range of travel.

2N1
ProxSensor™



VALVE POSITION TARGETS

Unique, symmetrically designed targets are mounted inside the valve position carrier. The targets are factory pre-aligned for Bray products. No cams or set screws are required and time consuming field adjustment is eliminated. Standard targets are stainless steel and non-magnetic. The sensors will not attract and be falsely tripped by loose metal objects. Magnetic targets are used for BUS network sensors. Standard non-adjustable targets are preset at 90° travel.

Adjustable Target (optional) allows the customer to individually set the valve position signal of both open and closed directions at incremental positions.

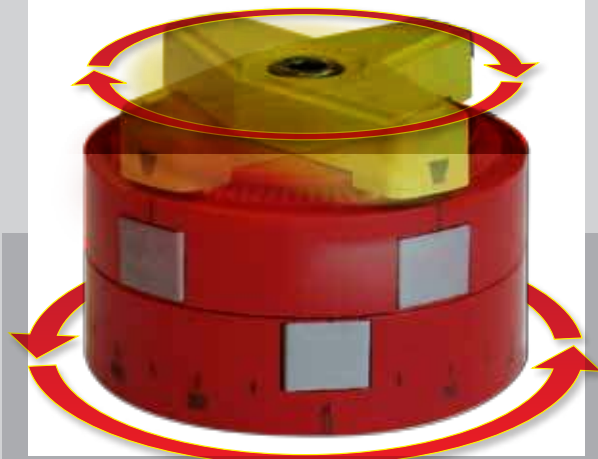

SERIES 52 MODELS

Inductive Proximity Sensors: These sensors are solid state electronic controls which provide high resolution, are spark free and contain no moving electrical parts to wear out.

DC Inductive Proximity Sensors: The standard DC sensors, offered as either PNP or NPN, have an economical internal amplifier and operate on 10VDC (200mA) to 30VDC (600mA). A NAMUR Intrinsically Safe DC sensor can be supplied for use with an IS barrier amplifier. The DC connector is M12, 4-pin.

AC Inductive Proximity Sensors: AC sensors operate on 20VAC (200mA) to 250VAC (500mA). No external switching amplifier is needed for AC applications. The AC connector is 7/8", 5-pin.

BUS Network Powered Proximity Sensors with Solenoid Drive:

Bray's BUS valve status monitors offer all the standard Series 52 features plus network communication and remote access to valve position and diagnostics. AS-i, DeviceNet and PROFIBUS DP units are available.

All network units contain two BUS powered proximity sensors, applicable network pin connection and a solenoid drive connection. They can be supplied with a Bray solenoid which may be powered by the network.



QUICK-CONNECT ACCESSORIES:

- Cordsets
- Extension Cords & Receptacles
- Cordsets (AC Sensors only)

INTEGRAL Y-CONNECTION

Bray offers a "Y" cable to combine a Series 52 and DIN solenoid into a single connection. The Y-Connection can be wired to a remote electrical junction box by either cordset, extension cord or conduit adapter. Bray can supply a Series 52, solenoid and actuator as a completely assembled system.

SERIES 52 ADVANTAGES

2N1 ProxSensor offers reduced installation cost as well as the following advantages:

vs. Mechanical Snap Acting Switches

- No switch sparking (arcing or wear)
- No contact bounce
- No moving switch elements
- Fully sealed enclosure

vs. Magnetic Reed Switches

- No switch sparking (wear)
- No contact bounce
- No moving switch elements
- Not fragile to vibration or shock

vs. Externally Mounted Proximity Switches

- 2 sensors in 1 enclosure
- No brackets required
- More compact design

vs. Two Inductive Proximity Switches in standard switchbox

- Lower cost
- More compact design
- Fully encapsulated enclosure



BRAY SERIES 6A

ELECTRO-PNEUMATIC POSITIONERS

Precision digital control with proven reliability Bray's Series 6A positioners were designed with ease of installation, simple calibration, efficiency and economy in mind. Units for rotary single acting and double acting actuators are offered as standard. Intrinsically safe versions are also available.

Bray's BUS positioners offer all Series 6A features plus increased network communication and remote access to positioner parameters and diagnostics.

ON-LINE ADAPTIVE CONTROL: During operation, the unit continually optimizes control behaviors and travel times in response to changes in line media pressure.

DIAGNOSTICS: Bray's Series 6A positioners feature corrective and preventative maintenance self-diagnostic checks. All diagnostics run constantly, may be continually monitored, and recorded.

AIR SUPPLY MONITOR: An additional feature of the Series 6A is an internal monitor that transmits a fault signal alarm if the air supply fails. The alarm is shown locally on the LCD and may be sent to the remote control panel.

LOCAL POSITION ADJUSTMENT: Valve position can be manually adjusted locally by removing the housing cover, then using the push buttons to override the remote command signal.

FLOW RESTRICTORS: Precise control of even the smallest pneumatic actuators through internal flow restrictors.

POSITION INDICATOR: In addition to the LCD display, valve position is clearly shown over a distance by a yellow indicator.

LOCKING DEVICE: For high vibration applications, the Series 6A features, as standard, a friction clutch locking device.

EXPLOSION PROOF UNITS

Designed for hazardous and severe applications, Series 6A explosion proof positioners offer all the features of the waterproof units in a flame-proof enclosure.

The automatic calibration keypad push buttons in the explosion proof units are externally mounted and easily accessible behind a flap. The units can be controlled locally, even during operation, without removing the housing cover. The LCD display is viewed from behind a sodium glass explosion proof window.

Waterproof/Explosion Proof enclosures meet NEMA 4, 4x, 7 & 9 specifications. These enclosures are constructed of die cast aluminum with an epoxy coating for chemical and corrosion protection. A waterproof stainless steel enclosure is available upon request.



Shown with optional gauges

MODULAR ACCESSORIES

GAUGE MANIFOLD: An externally mounted gauge manifold is offered with up to three gauges to measure air supply and the actuator input and output pressures.

VOLUME BOOSTERS: These modules increase air volume output and decrease response time.

OPTIONAL BOARDS

These optional boards provide additional information and features and can be easily installed in the field.

RETRANSMISSION MODULE (IY): This 4-20mA DC output board indicates valve position to the control room.

PROGRAMMABLE ELECTRONIC SWITCHES (ALARM): Two semiconductor switch outputs and one alarm output may be programmed to activate at various travel positions. One digital input is also included.

LIMIT SWITCHES: For cam activated indication of actuator travel limits, two output formats are offered: Mechanical Switches or intrinsically safe Inductive Proximity Switches (SIA).

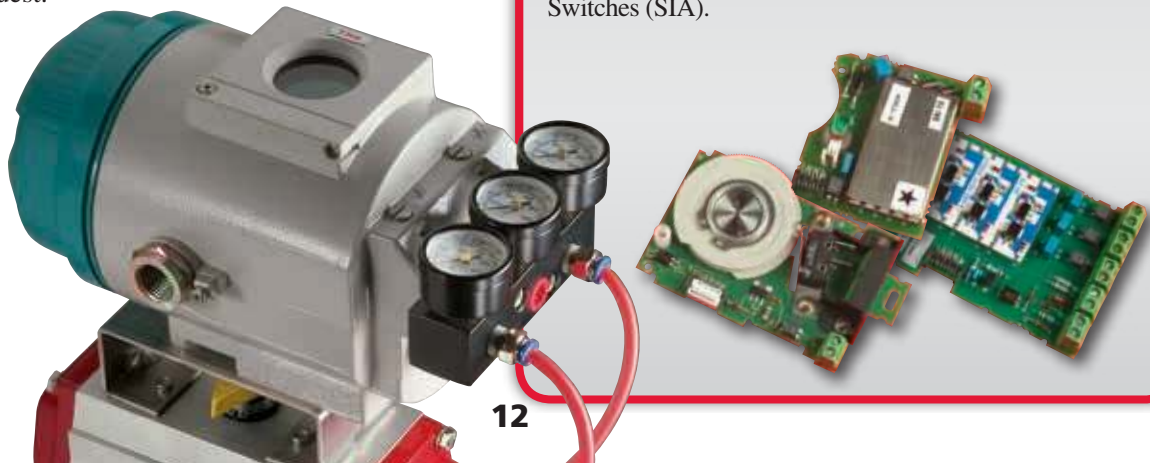

LCD DISPLAY & KEYPAD: Provides visual confirmation of valve position in precise one degree increments, operating status and keypad entries with the housing cover in place. The positioner operating mode (automatic or manual) and alarm messages are also shown.

With the housing cover removed, the keypad push buttons are accessible to perform a variety of functions:

- Confirmation of the set point
- Progress to the set point
- Potentiometer alignment
- Diagnostic checks
- Error messages

ENCLOSURES: The standard waterproof enclosure is constructed of a durable, lightweight polymer, providing excellent chemical and corrosion resistance.

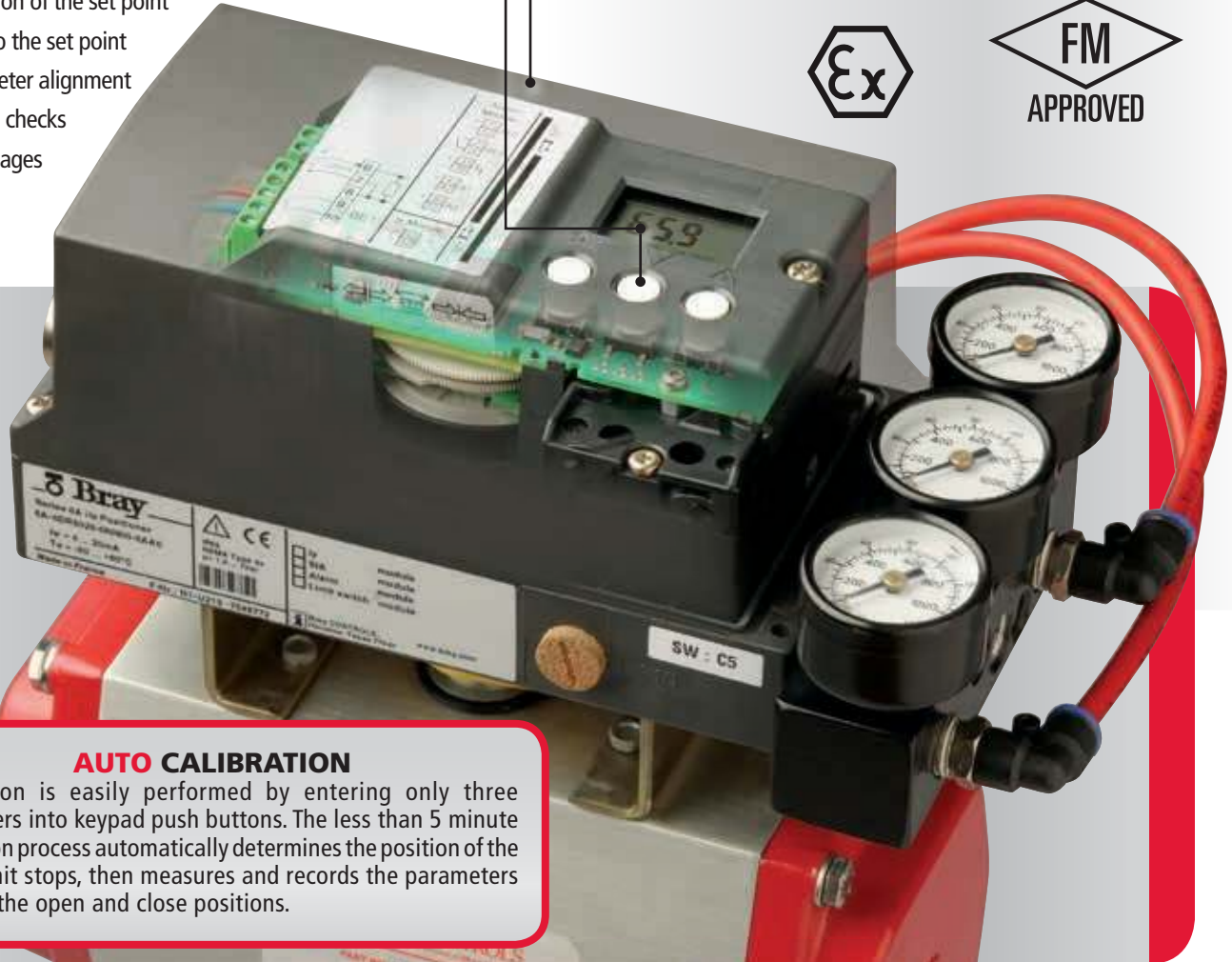

AUTO CALIBRATION

Calibration is easily performed by entering only three parameters into keypad push buttons. The less than 5 minute calibration process automatically determines the position of the travel limit stops, then measures and records the parameters for both the open and close positions.

SERIES 6A WATERPROOF UNITS - SPECIFICATIONS

Supply Pressure [Max]	20 - 102psi (1.4-7Bar)	Weight	2.0 lbs. (0.9 kg)
Air Consumption (80psi)	<0.00035 scfm (.00275 sccm)	Control Element Type	Piezoelectric
Input Signal		EMC Requirements	EN 61326/A1 Appendix A.1 NAMUR NE21 August 98
Analog	4-20 mADC	Protection Class	NEMA 4, 4x and IP66
BUS	HART, Foundation Fieldbus, Profibus PA	Materials	
Connections		Housing	Fiberglass Reinforced Polymer with Metalized Coated interior for EMC protection
Supply	1/4" NPT (G 1/4")	Housing Fasteners	Stainless Steel
Signal (2 conduit entries)	1/2" NPT (M20x1.5)	Position Indicator	ABS polymer
Resolution	<0.05%	Positioner Mounting	VDI/VDE 3845 (NAMUR)
Repeatability	0.32%	Available Approvals	FM, CSA, CE, ATEX
Hysteresis	<0.2%		
Temperature Range	-22°F to +176°F (-30°C to +80°C)		

SERIES 6P PIP POSITIONER

FOR DOUBLE ACTING & SPRING RETURN ACTUATORS

The Bray Series 6P positioner provides outstanding control for a wide range of quarter-turn valves. This design provides fast, sensitive response characteristics to meet the most demanding control objectives using a 3-15 psi pneumatic control signal. A high visibility dome position indicator and 3 gauges are provided as standard.

APPLICATIONS

Bray Series 6P positioners are used to control quarter-turn control valves such as butterfly and ball valves (standard and segmented) and its sensitive two-stage relay makes it ideal for precise damper control applications. Specify Bray Series 6P whenever valve positioning and sensitivity is critical.

For modulating control of valve positions, the Series 6P automatically positions the valve to precise angles between 0° and 90° in response to a pneumatic input signal. The standard positioner is Double Acting but can be easily converted to Single Acting/Spring Return. The 6P also has Split Range capabilities and an easy to adjust Span and Zero.

MOUNTING & MATERIALS

The Series 6P can be installed directly on any quarter-turn valve actuator conforming to the NAMUR standard.

Contact your local Bray Distributor for information about mounting the 6P on non-NAMUR actuators.

The Series 6P enclosure is IP66 rated and is constructed from durable die-cast aluminum that is first anodized for internal corrosion resistance, then powder coated for external resistance to harsh environments.

STANDARD FEATURES

- 1. Two-Stage Pilot Relay:** Provides fast, sensitive response characteristics for precise control of critical control valves and dampers.
- 2. Corrosion Resistant Materials:** All exposed parts are either stainless steel or powder coated anodized aluminum to permit use in corrosive environments.
- 3. High Visibility Dome Position Indicator:** Provides high-contrast, full-angle viewing of valve position.
- 4. Vibration Resistant:** High natural frequency and pneumatic dampening make the Series 6P resistant to vibration.
- 5. Gauge Manifold:** 3 gauges are provided for Signal, OUT 1, and OUT 2 ports.
- 6. Double or Single Acting**
- 7. Adjustable NAMUR Mounting Bracket**



OPTIONS / ACCESSORIES

Special Cams: Special cams for non-standard ranges may be modified by the factory or customer.

Air Filter: A coalescing air filter is recommended for all positioners to eliminate dust, moisture, and oil particles from contaminating the unit.

Mechanical Switches: Limit switches may be added to the Series 6P to provide position feedback. Switches are available as 2 x SPDT or 2 x DPDT for AC or DC applications.

Proximity Sensor: For non-contacting limit switch applications, 2 x DC-NPN are available to provide open and close valve indication.

Position Transmitter: A 4-20mA position transmitter provides continuous valve position indication from 0 – 90 degrees of travel.

SERIES 55

FILTER REGULATORS

The Bray Series 55 Filter Regulator is a 5 micron filter designed to provide nominal filtration removal of solids and liquids from the compressed air with accurate control to any pneumatic control device and are strongly recommended for use with the Bray Series 64 and 6A positioners.

LOCKING KNOB: Allows for downstream pressure adjustment and locks the pressure setting in place.

THREADED COLLAR: Permits easy attachment of bracket for panel mounting.

PRESSURE PORTS: 1/4" NPT or 1/4 G Metric

BOWL QUICK RELEASE: Allows for easy removal of the bowl and guard for access to the filter element without the need for special tools.

TRANSPARENT POLYCARBONATE BOWL: Provides easy view of liquid levels.

METAL BOWL GUARD: Provides sturdy breakage protection from external environmental factors.

PUSHBUTTON DRAIN: Allows for easy removal of liquid from the bowl.

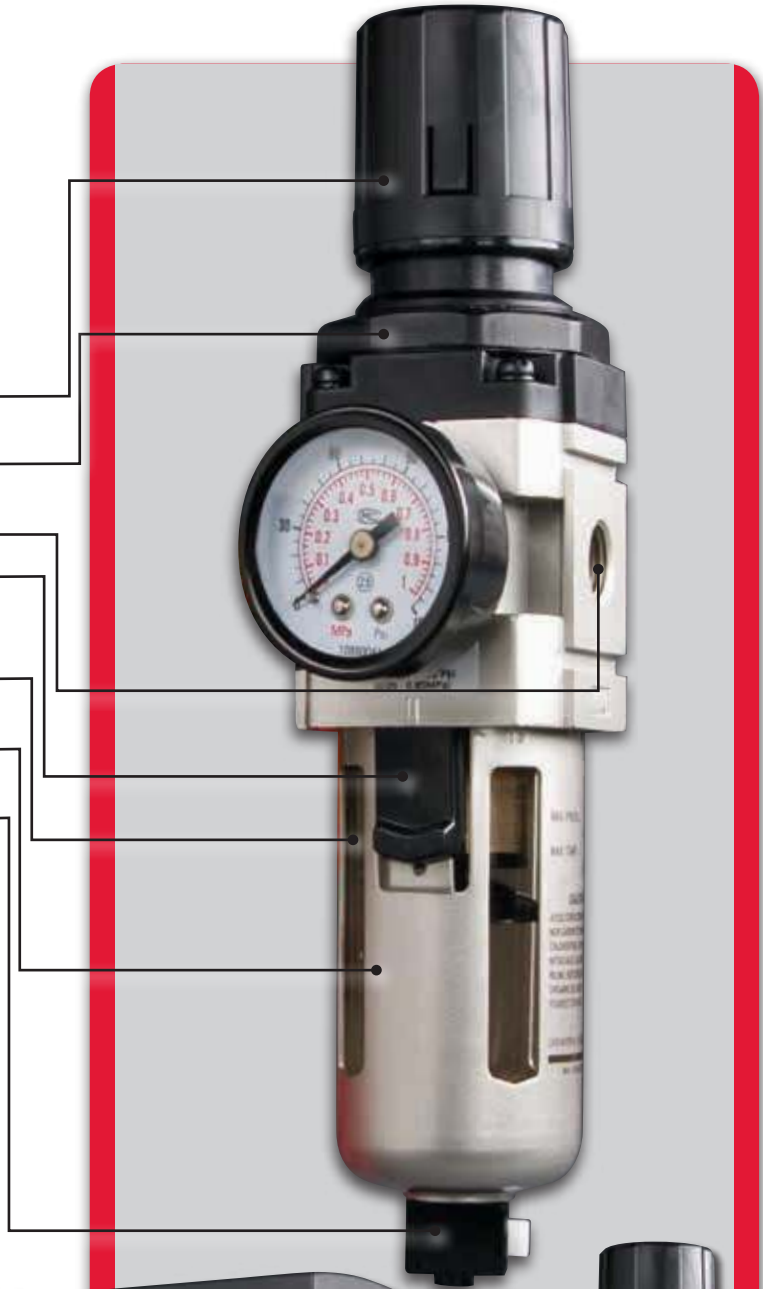

SERIES 55 FILTER REGULATORS

Pressure Ports	1/4" NPT or G 1/4
Gauge Ports	G 1/8
Flow (SCFM)*	30
Set Pressure	7 – 125 PSIG (0.05 - 0.85 MPa) (0.5 - 8.6 Bar)
Filter Regulator Body	Zinc / Non-Removable Rising Knob
Bonnet	Plastic
Springs	Steel
Bowls (2 Ounce)	Transparent Polycarbonate with Metal Guard Metal (Zinc) w/Sight Gauge
Filter Element	5 Micron Standard – Plastic
Pressure Ratings**	0 – 250 PSIG (0 - 1.70 MPa) (0 – 17.2 bar)
Temperature Ratings	32°F - 175°F (0°C - 80°C)

*SCFM = Standard cubic feet per minute at 100 psig inlet, 90 psig no flow secondary setting and 10 psig pressure drop.

**Do not attach to pressurized gas bottles.





Global Manufacturing, Service Around the Corner

To serve you locally, each region maintains a factory certified sales and service network for all Bray International products.

BRAY INTERNATIONAL, INC.

Houston, TX +281.894.5454

BRAY CONTROLS

USA

Houston, TX +281.894.5454

ARGENTINA

Buenos Aires +54.11.4362.0666

BENELUX

Heerhugowaard +31.72.572.1410

BRAZIL

Paulinia SP-Brazil +55.19.3517.6161

CANADA

Montréal +514.344.2729

CHILE

Santiago +56.2739.2966

CHINA

Hangzhou, Zhejiang +86.571.828.52200

GERMANY

Krefeld +49.2151.53360

INDIA

Gujarat +91.265.2633868

MEXICO

Zapopan, Jalisco +52.33.3836.4460

PACIFIC

Melbourne, Australia +61.3.8541.2555

PERU

Lima +511.251.0251

POLAND

Oświęcim +48.33.842.1968

UNITED KINGDOM

Inchinnan +44.141.812.5199

VIETNAM

Ho Chi Minh City +84.8.3742.3428

FLOW-TEK

USA

Houston, TX +832.912.2300

BRAZIL

Paulina SP-Brazil +55.19.3517.5555

CHINA

Hangzhou, Zhejiang +86.571.828.52200

RITEPRO

CANADA,

Montréal +514.324.8900

CHINA,

Hangzhou, Zhejiang +86.571.828.52200



Bray **CONTROLS**
 Division of BRAY INTERNATIONAL, Inc.

13333 Westland East Blvd., Houston, Texas 77041
 281.894.5454 Fax 281.894.9499 www.bray.com

All statements, technical information, and recommendations in this bulletin are for general use only. Consult Bray representatives or factory for the specific requirements and material selection for your intended application. The right to change or modify product design or product without prior notice is reserved. Patents issued and applied for worldwide.

Bray® is a registered trademark of BRAY INTERNATIONAL, Inc.
 © 2015 Bray International. All rights reserved.